

ERSATZTEILPREISLISTE A10/A11 / SPARE PART PRICELIST A10/A11

für selbsttätige Zugmäuler A10 (D 30mm) und A11 (D 38mm)
 for automatic coupler head A10 (D 30mm) and A11 (D 38mm)

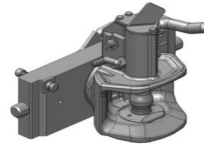

Pos.	Art.Nr.	Sets	Bemerkung / Note
0.01	02.480.010	Kuppelbolzen A10 / coupler bolt A10	Pos. 3-5,24,25,44,45
0.01.1	02.480.012	Kuppelbolzen A10 / coupler bolt A10 ab/from 10/2009	Pos. 3,4,5.1,24,25,44,45.1
0.02	02.480.020	Kuppelbolzen A11 / coupler bolt A11	Pos. 1-5, 24, 25
0.02.1	02.480.021	Kuppelbolzen A11 / coupler bolt A11 ab/from 10/2009	Pos. 1, 2.1,3.1,4, 5.1, 24, 25
0.03	02.480.025	Büchse / bushing	Pos. 24,25
0.04	02.480.050	Klinke / latch	Pos. 6-8 bis/to 10/2009
0.04.1	02.480.051	Klinke / latch	Pos. 6.1-8 ab/from 10/2009
0.05	02.480.060	Niederhalterblech / keeper sheet	Pos. 26-28
0.06	02.480.100	Auslösezunge / tripping tongue	Pos. 9-11
0.07	02.480.120	Deckel A10 / cover A10	Pos. 38, 43
0.08	02.480.130	Deckel A11 / cover A11	Pos. 38,41
0.09	02.480.140	Deckel A10-A11 System Fendt / cover A10-A11 Sys.Fendt	Pos. 36-38
0.10	02.480.150	Bügel / bracket	Pos. 39,40
0.11	02.480.250	Fernbedienhebel F1 / remote control lever F1 A10/A11	Pos. 13,15 bis/to 10/2009
0.11.1	02.480.251	Fernbedienhebel F1 / remote control lever F1 A11/A10	Pos. 13,15.1 ab 10/2009
0.12	02.480.270	Fernbedienhebel F2 / remote control lever F2 A10/A11	Pos. 12-14 bis/to 10/2009
0.12.1	02.480.271	Fernbedienhebel F2 / remote control lever F2 A10/A11	Pos. 12.1-14 ab 10/2009
0.13	02.480.350	Auslösehebel / release lever	Pos. 34, 35
0.14	02.480.400	Anzeigeeinheit A10 (bis 10-98) / indicator A10 (to 10-98)	Pos. 9, 30,33,42
0.15	02.480.410	Anzeigeeinheit A11 (bis 10-98) / indicator A11 (to 10-98)	Pos. 9, 30-33
0.16	02.480.500	Betätigungsgriff / handle bis/to 10/2009	Pos. 16-19, 21-23
0.16.1	02.480.502	Betätigungsgriff / handle ab/from 10/2009	Pos. 16.1-19.1 21,22.1/23.1
Pos.	Art.Nr.	Einzelteile / components	Bemerkung / Note
1	20.173.136	Zylinderstift 10x36 / parallel pin 10x36	
2	10.745.500.0	Kuppelbolzen A11 d38 / coupler bolt A11 d38	bis/to 10/2009
2.1	10.745.502.0	Kuppelbolzen A11 d38 / coupler bolt A11 d38	ab/from 10/2009
3	20.173.081	Zylinderstift 8x16 / parallel pin 8x16	bis/to 10/2009
3.1	20.173.0813	Zylinderstift 8x18 / parallel pin 8x16	ab/from 10/2009
4	10.752.801.1	Lasche / link plate	
5	10.753.100.1	Mittelhebel 76x40x6 / lever 76x40x6	bis/to 10/2009 / 6mm
5.1	10.753.102.1	Mittelhebel 76x40x8 / lever 76x40x8	ab/from 10/2009 / 8mm
6	10.741.100.0	Klinke / latch	bis/to 10/2009 / 6mm
6.1	10.741.102.0	Klinke / latch	ab/from 10/2009 / 8mm
7	20.173.056	Zylinderstift 5x60 / parallel pin 5x60	
8	20.151.052	Klemmring mit Kappe / locking ring with cap	
9	20.180.061	Druckfeder 6x16 / pressure spring 6x16	
10	10.758.100.0	Zunge / tongue	
11	20.180.253	Druckfeder Zunge 13x40 / pressure spring tongue 13x40	
12	10.881.500.0	Fernbedienhebel F2* / remote control lever F2* A10/A11	bis/to 10/2009
12.1	10.881.501.0	Fernbedienhebel F2* / remote control lever F2* A10/A11	ab/from 10/2009
13	20.181.061	Zugfeder 8x18 / tension spring 8x18	
14	20.172.310	Spannstift 3x10 / spring pin 3x10	
15	10.881.250.0	Fernbedienhebel F1* / remote control lever F1* A10/A11	bis/to 10/2009
15.1	10.881.251.0	Fernbedienhebel F1* / remote control lever F1* A10/A11	ab/from 10/2009
16	20.172.316	Spannstift 3,5x16 DIN1481 / spring pin 3,5x16 DIN1481	bis/to 10/2009
16.1	20.172.314	Spannstift 3x24 DIN1481 / spring pin 3x24 DIN1481	ab/from 10/2009
17	20.167.043	Distanzscheibe 10/20x0,3 / washer 10/20x0,3	
18	20.167.045	Distanzscheibe 10/20x0,5 / washer 10/20x0,5	
19	20.165.100	Scheibe M10 / washer M10	bis/to 10/2009
19.1	20.167.050	Distanzscheibe 16x26x1 / washer 16/26x1	ab/from 10/2009
20	20.181.020	Drehfeder 32 / torsion spring 32	
21	20.167.050	Distanzscheibe 16/26x1 / washer 16/27x1	
21.1	20.167.0550	Distanzscheibe 20/32x1 / washer 20/32x1	ab/from 10/2009
22	10.730.510.0	Handgriff A10-A11 / handle A10-A11	bis/to 10/2009 / Ø16mm
22.1	10.730.505.0	Handgriff A10-A11 / handle A10-A11	ab/from 10/2009 / Ø20mm
23	20.172.640	Spannstift 6x40 / spring pin 6x40	ab/from 10/2009
24	10.713.100.0	Büchse 74x40x31,6 / bushing 74x40x31,6	
25	20.106.071	Sk-Schraube M8x20 DIN 933 / hex-screw M8x20 DIN 933	
26	10.754.210.0	Niederhalterblech / keeper-plate	
27	20.120.080	Mutter M8 DIN 934 / nut M8 DIN 934	
28	20.118.005	Torbandschraube M8x25 / screw M8x25	
29	10.711.100.0	Anzeigeeinheit / indicator	
30	10.711.420.0	Anzeigestift / indicator pin	

31	20.151.052	Achsenklemmring D5 / <i>locking ring</i>		
32	10.711.300.0	Anzeigegehäuse A11 / <i>indicator housing A11</i>		
33	20.103.021	ISK-Schraube 6x12 DIN 912 / <i>hex. socket screw 6x12</i>		
34	10.732.200.0	Auslösehebel / <i>release lever</i>		
35	20.151.101	Klemmring mit Kappe / <i>locking ring with cap Ø 10</i>		
36	10.720.400.0	Deckel mit Schutzbügel A10-A11 / <i>cover A10-A11</i>	System Fendt	
37	20.164.060	Fächerscheibe M6 / <i>serrated lock washer M6</i>		
38	20.106.043	SK-Schraube M6x12 DIN933 / <i>hex-screw M6x12 DIN933</i>		
39	20.106.045	SK-Schraube M6x16 DIN933 / <i>hex-screw M6x16 DIN933</i>		
40	10.756.500.0	Schutzbügel / <i>protector</i>		
41	10.720.250.0	Deckel A11 Standard / <i>cover standard A11</i>	1/99/223	
42	10.711.200.0	Anzeigegehäuse A10 / <i>indicator housing A10</i>		
43	10.720.210.0	Deckel A10 Standard / <i>cover standard A10</i>		
44	20.173.130	Zylinderstift A10 10x30 / <i>parallel pin A10 10x30</i>		
45	10.745.100.0	Kuppelbolzen A10 / <i>coupler bolt A10</i>	bis 10/2009	
45.1	10.745.102.0	Kuppelbolzen A10 / <i>coupler bolt A10</i>	ab 10/2009	
47	20.165.065	Scheibe / <i>washer</i>	für / <i>for</i> Pos. 36	
48	20.164.080	Fächerscheibe M8 / <i>serrated lock washer M8</i>	für / <i>for</i> Pos. 26	
51	10.721.100.0	Gummidichtung A10 / <i>seal A10</i>		
52	10.721.200.0	Gummidichtung A11 / <i>seal A11</i>		
53	10.720.211.0	Deckel A10 f. F1 FBD Scharmüller / <i>cover A10 F1 Scharm.</i>		
54	10.720.213.0	Deckel A10 CNH / <i>cover A10 CNH</i>		
55	10.720.257.0	Deckel A11 CNH / <i>cover A11 CNH</i>		

In Scharmüller Automatikköpfe passen alle Ersatzteile mit folgenden Einschränkungen: (Bauartbedingte Unterschiede)
 All spareparts fit into Scharmüller automatic coupler heads except following parts: (different construction types)

Gehäuse A10 mit 31mm Kuppelbolzen Housing A10 with 31mm Coupler Pin

Pos. 44 + 45 Zylinderstift + Kuppelbolzen / *coupler bolt + parallel pin*
 Pos. 43 Deckel / *cover*
 Pos. 42 Anzeigegehäuse / *indicator housing*
 Pos. 53 Deckel für Fernbedienung F1 Scharmüller / *cover for remote control F1 Scharmüller*

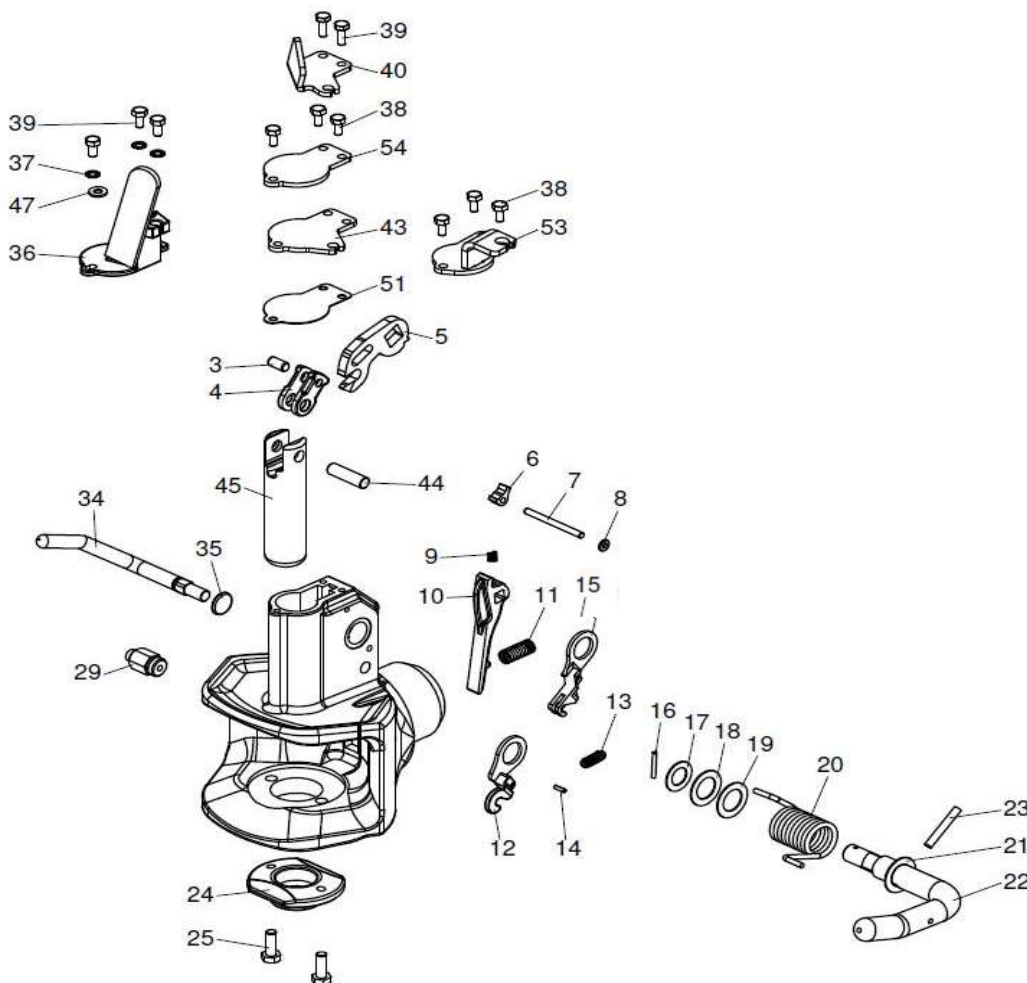

Gehäuse A11 mit 38mm Kuppelbolzen Housing A11 with 38mm Coupler Bolt

Pos. 1 + 2 Zylinderstift + Kuppelbolzen / coupler bolt + parallel pin

Pos. 41 Deckel / cover

Pos. 55 Deckel für CNH Steyr Kompakt Modelle / cover for CNH Steyr Kompakt types

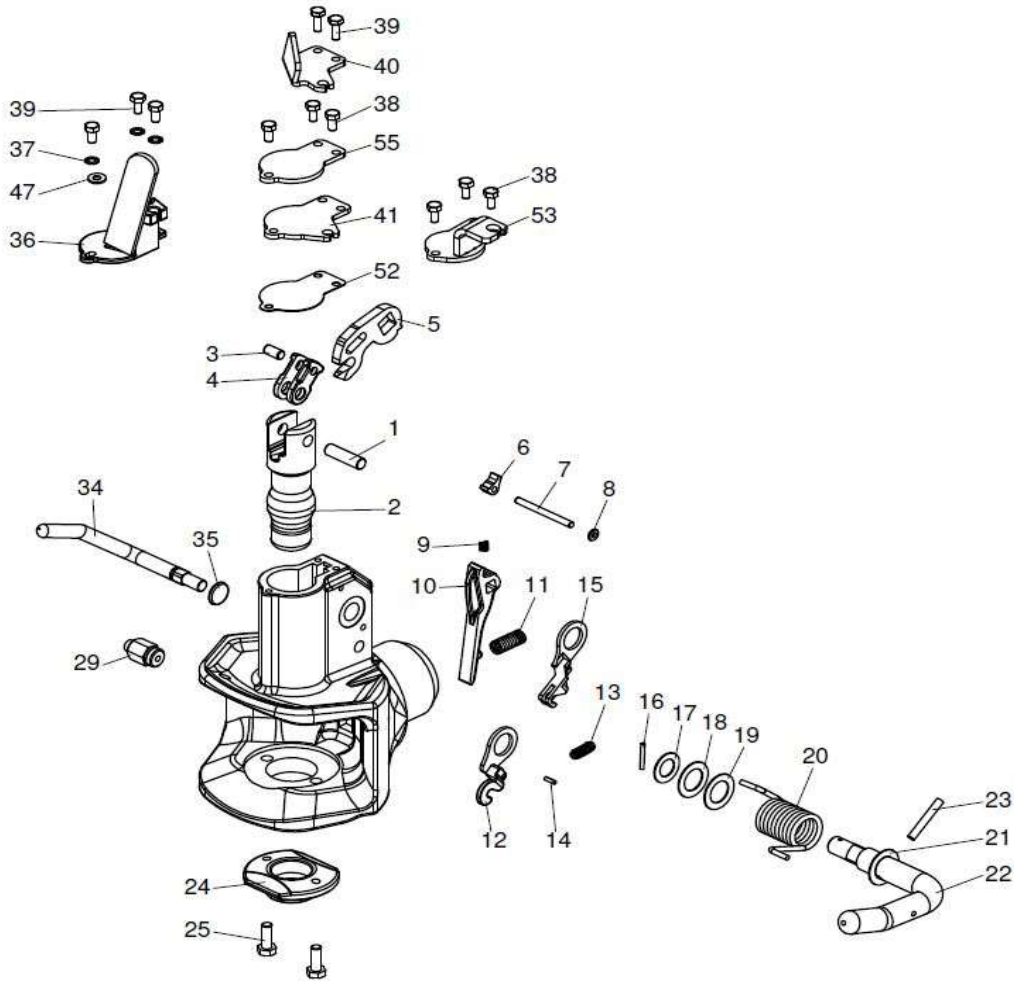

* F1 / F1 Fernbedienungs-vorbereitung für Fernbedienung Scharmüller
Remote Control Preparation for Remote Control Scharmüller

* F2 / F2 Fernbedienungs-vorbereitung für Fernbedienung von Fremdherstellern
Remote Control Preparation for Remote Control of other Producer

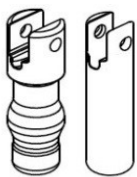

Pos. 2 / 45: bis/to 10/2009 Nut / slot 16 mm

Pos.2.1 / 45.1: ab/from 10/2009 Nut / slot 18 mm



Pos. 5: bis/ up to 10/09

Dicke 6 mm Vierkant 10mm / thickness 6 mm square 10mm

Pos. 5.1: von / from 10/09

Dicke 8 mm Vierkant 15mm / thickness 8 mm square 15mm



Pos. 22: bis/to 10/09 / Vierkant / square 10 d 16mm

Pos. 22.1: ab/from 10/09 Vierkant / square 15 d 20mm

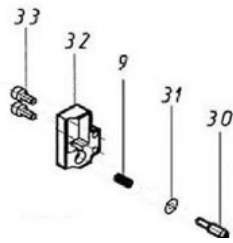

Pos. 9 + 30 - 33: bis / up to 10/98

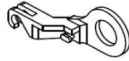

Fernbedienungsvorbereitung F1 / F2
Remote control preparation F1 / F2

Pos. 12 / 15: bis/ up to 10/09 d 16 mm
Pos. 12.1/ 15.1: von / from 10/09 d 20 mm

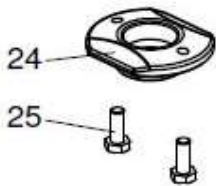

Pos. 24:

Art. Nr. 10.713.100.0 Einbaumaß 40 mm stand.

Art. Nr. 10.713.090.0 Einbaumaß 38 mm bis / up to 05/90



Klinke / Latch

Pos. 6: bis/ up to 10/09 dicke / thickness 6mm



Pos. 6.1: von / from 10/09 dicke / thickness 8mm